

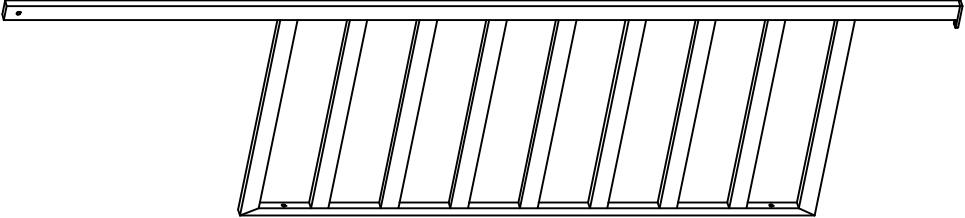

NO.	PARTS	QTY
G		1pc
6		1pc
8		2pcs
X4	 M6*30	3pcs
4		1pc
		1pc

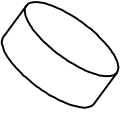

or

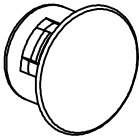
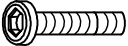
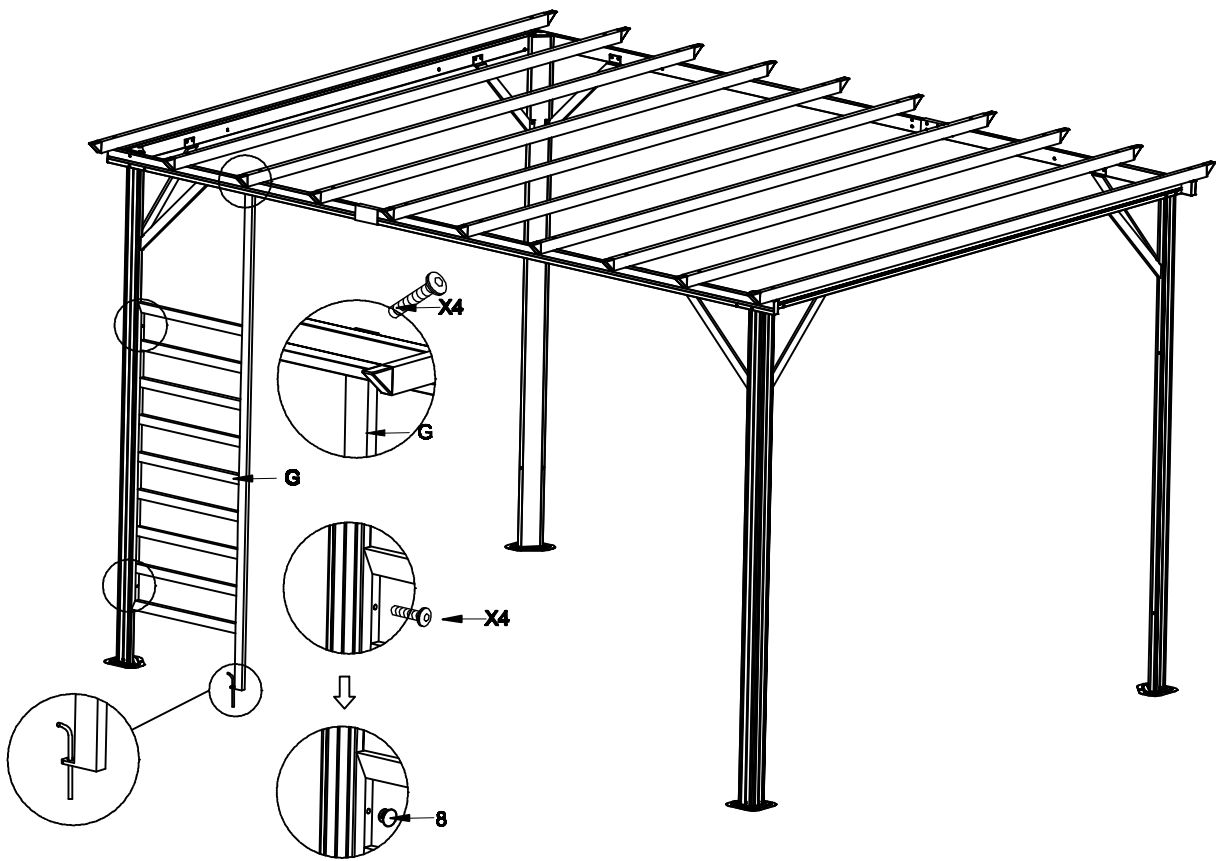